

PROMET

Feel Safe ■

PRODUCT CATALOGUE

We will make it easy for you to make a purchase decision by selecting from our extensive range of products marked with the following symbols.



Products marked with this sign are best selling products. For our business partners it is a guarantee of sales success and customer satisfaction.



Products marked with this trademark are highly competitive, feature more functionality, or exceptionally attractive price / quality ratio. Our trading partners give it more arguments in relation to the customer and ensure increased sales.



Our new products are those that respond to your current market needs so that your offer is even more diversified and competitive.



ECB-S is the largest international security product certification body, bringing together the most prestigious research institutes in Europe. Possession of the ECB-S certificate is confirmation of the highest standards of protection.



The patented filling formula gives you less weight while maintaining the highest safety standards. Reduced weight is an advantage for transportation and assembly.



Patented, special type of Ultra High Performance Concrete, with increased hardness compared to traditional concrete, comparable to solid stone.



Quality without compromise. Products bearing this mark are characterized by the highest standards of manufacture and the most up-to-date technologies and materials.



Laser cutting technology used in our production process allows for greater precision of the structure.

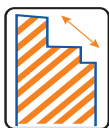

The products marked with this sign feature a multi-layer reinforced door and wall construction. This is the «safe in safe» effect.



Multilayered construction. In products marked with this sign the walls consist of alternating layers of sheet metal and special reinforced fillings.

Content

2 Promet Worldwide

4 Manufacturing

Commercial Safes

7 GRANIT **Grade I, LFS 30 P**

8 GARANT **Grade I, LFS 60 P**

10 LYON **Grade I, LFS 30 P**

11 BASTION M **Grade II, LFS 30 P**

13 FORT M **Grade III, LFS 30 P**

14 BANKER **Grade IV**

15 BURGAS **Grade V, LFS 30 P**

Private Safes

17 SB **Grade S2**

18 BRF **Grade S2, LFS 30 P**

20 FSB **Grade S2, LFS 60 P**

21 BARRIER **Grade 0**

22 ASK **Grade I**

Double Doors Safes

25 BRANDMAUER **Grade S2**

26 FSB **Grade S2, LFS 60 P**

27 GARANT **Grade I, LFS 60 P**

Deposit Safes

29 ASD **Grade S1**

30 DSC **Grade DI**

Gun Safes

33 ARSENAL **Grade S1**

35 ASG/WS **Grade I, LFS 30 P**

Fire Resistant Safes

37 FC **LFS 60 P**

38 FRS **LFS 60 P**

41 FRS PLUS **NT FIRE 90 P**

Vault Doors

43 AVD **Grade III**

45 AVD **Grade V**

Furniture Safes

47 T

Technical Information

49 Locks, Dials, Keypads,

52 Transport information

55 Security levels and insurance amounts

56 General terms and conditions

PROMET Worldwide

Markets

- | | | | |
|------------------------|------------|-------------|--------------|
| Austria | France | Libya | Sudan |
| Azerbaijan | Germany | Macao | South Korea |
| Australia | Georgia | Macedonia | Sweden |
| Bahrain | Greece | Morocco | Spain |
| Belarus | Hong-Kong | Netherlands | Switzerland |
| Belgium | Iran | Nigeria | Tajikistan |
| Bosnia and Herzegovina | Iraq | Oman | Trinidad |
| Croatia | Israel | Palestine | Turkmenistan |
| Denmark | Jordan | Poland | Tunis |
| Egypt | Kuwait | Portugal | UAE |
| Estonia | Kyrgyzstan | Qatar | Ukraine |
| Ethiopia | Latvia | Romania | UK |
| Finland | Lithuania | Russia | USA |
| | Lebanon | Serbia | |

Our history

- | | | | | |
|---|---|---|--|---|
| <p>1991
 April
 Start promoting first sales of safes.</p> | <p>1993
 November
 Begin expansion of our distribution network.</p> | <p>2000
 April
 Launch of our first manufacturing facility.</p> | <p>2001
 September
 Our quality management program is certified to ISO 9001.</p> | <p>2008
 July
 Launch of our second and third manufacturing facilities.</p> |
|---|---|---|--|---|

Quality

Our approach - provide durable products that meet the highest expectations of our buyers by manufacturing our products to the highest standards.



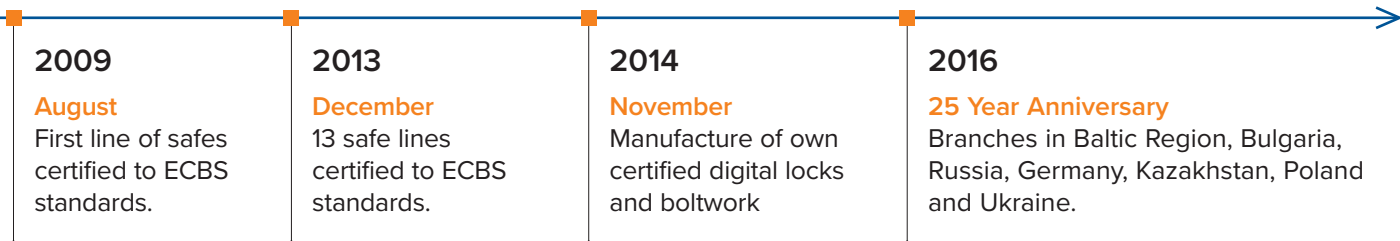
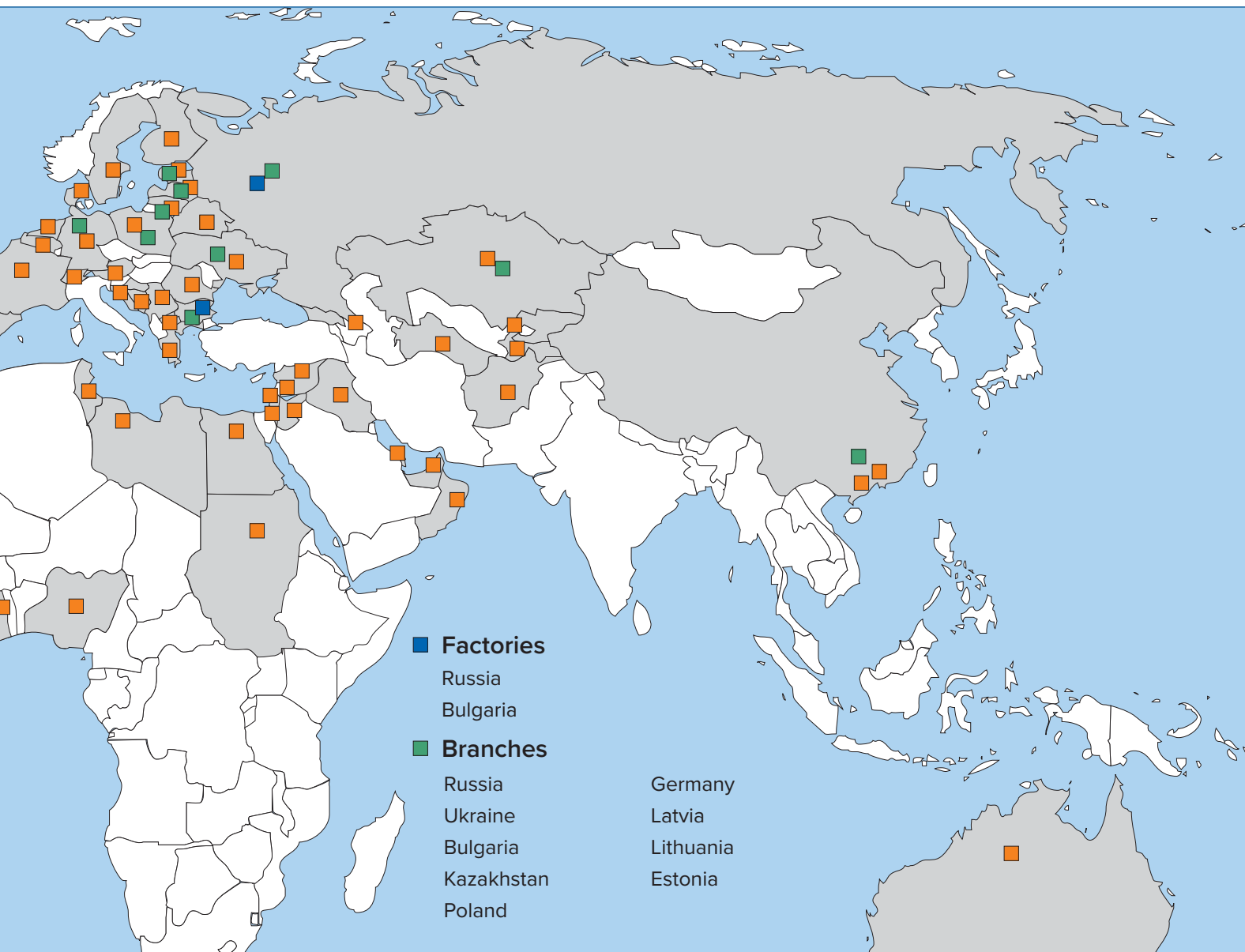

As of september 2001 our quality managment system is certified to the ISO 9001. One of the leading certification organizations in the world, Det Norske Veritas, is acting as our certifying body.





Manufacturing



Group of companies Promet is one of the leading safe manufacturers. The Group has three factories including the main export plant located in the European Union, the Republic of Bulgaria.



The production philosophy is based on the management principles of “lean manufacturing”.



The plants implement measures allowing optimized environmental use and minimized environmental pollution resulting from the production.



The plants are equipped with the most advanced metal processing equipment, which is not only sufficiently effective and suitable for production on a large scale, but also flexible and adjustable for manufacturing of a wide range of items and switching quickly among various production types.



Equipment

- Automatic punching lines
PIVATIC
- Laser cutting systems
BYSTRONIC
- Punch presses
FINNPOWER, AMADA
- Bending machines
FINNPOWER, AMADA
- Welding robots
MOTOMAN
- Powder coating
GEMA

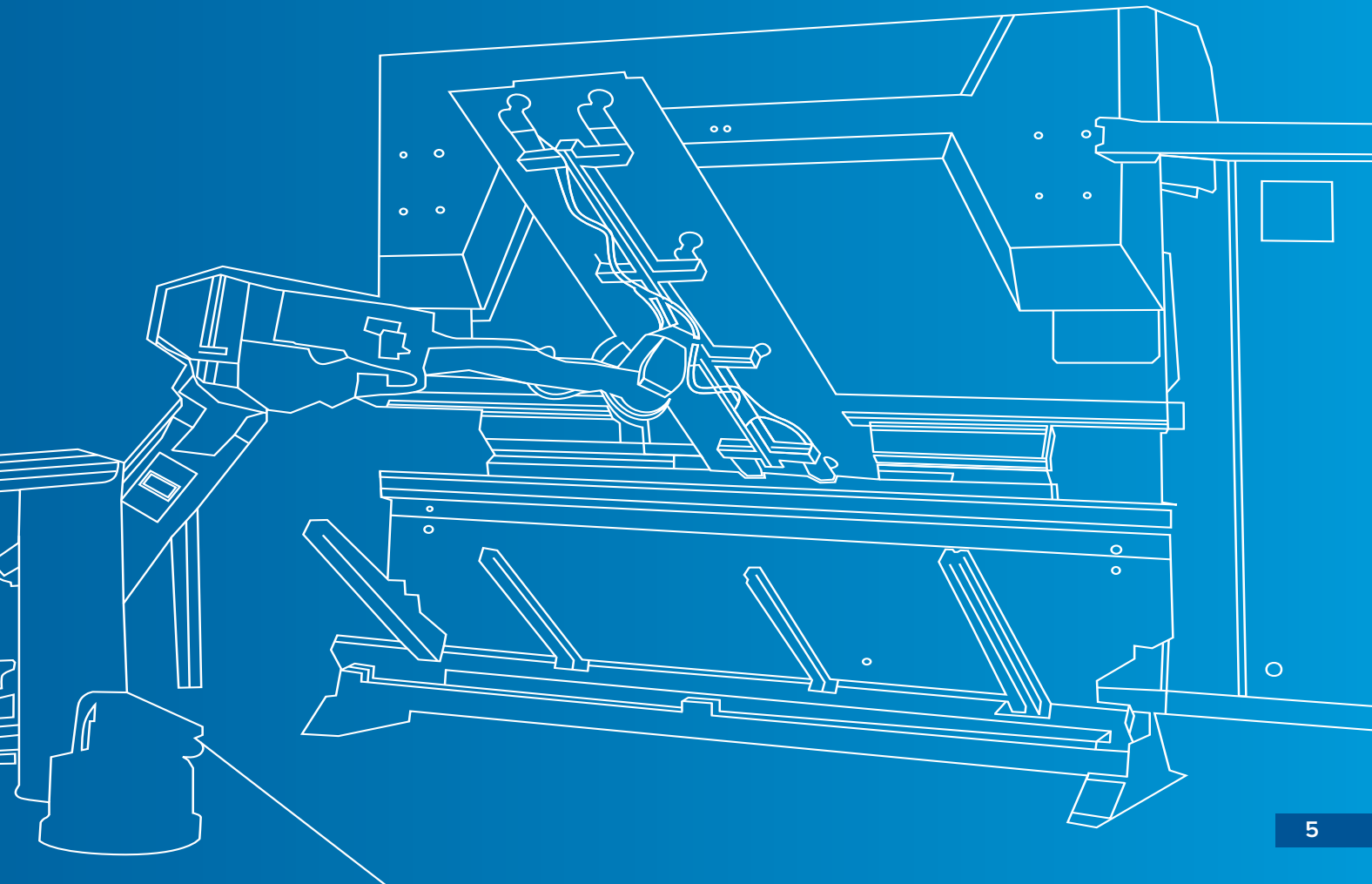

COMMERCIAL SAFES



Commercial Safes

VALBERG

series: **Granit**
grade: **I, LFS 30 P**

YOU GOT MORE

LASER
Cut
EFFECT

MULTI
LAYER SYSTEM

GRADE I
ECB-S
certified

LFS 30 P
ECB-S
certified

BEST
SELLER



GRANIT 90



GRANIT 65

Model										
Granit 3450	340	500	345	262	424	216	1	6	93	24
Granit 4450	440	500	432	362	424	302	1	6	128	46
Granit 46	460	440	430	382	364	300	1	4	119	42
Granit 5450	540	500	432	462	424	302	1	6	149	59
Granit 6465	638	650	550	550	574	420	2	8	233	135
Granit 65	655	440	430	574	364	300	1	6	155	63
Granit 8465	840	650	550	782	574	420	2	8	289	189
Granit 90	900	440	430	822	364	300	2	9	205	90
Granit 1065*	1041	650	554	963	574	424	2	9	345	234
Granit 1265*	1241	650	554	1163	574	424	2	10	426	283



Key lock
Kaba 7111



Digital lock
Grade B (PS-600)

The outer depth is given without the handle and the lock.

* Grade 1 only (no certified fire protection)

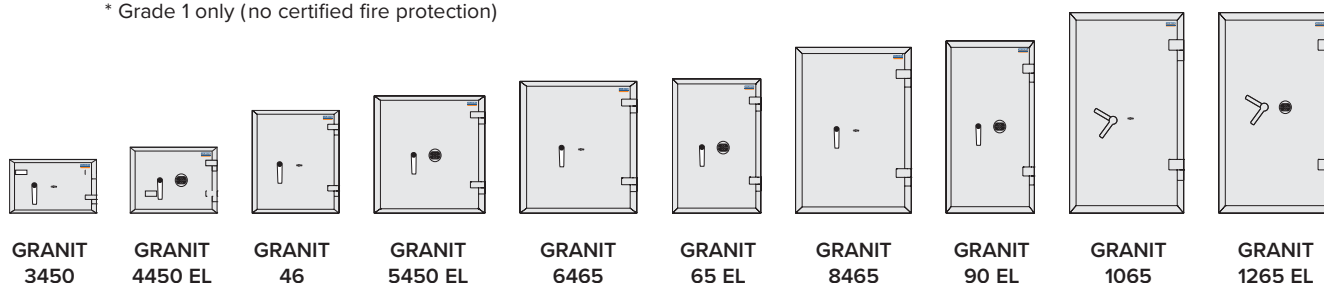

GRANIT 3450

GRANIT 4450 EL

GRANIT 46

GRANIT 5450 EL

GRANIT 6465

GRANIT 65 EL

GRANIT 8465

GRANIT 90 EL

GRANIT 1065

GRANIT 1265 EL

- Burglary resistance – EN 1143-1, Grade I.
- Fire resistance – LFS 30P according to EN 15659.
- The safe body and door are manufactured with two inter-welded walls that are filled with concrete.
- Three way locking bolts.
- Integrated relocker, lock secured from drill attacks.
- Standard delivery with double-bit high security key lock with two keys.
- Anchoring to the floor.
- Color: RAL 7035 (light grey), also available in RAL 7024 (grey graphite).

Commercial Safes

series: **Garant**
grade: **I, LFS 60P**

VALBERG

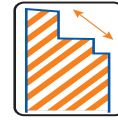

GARANT 67



GARANT 46

Model											
Garant 46	490	480	455	330	332	295	1	8	106	33	
Garant 67	670	480	455	510	332	295	1	8	136	49	
Garant 75	750	555	547	590	407	388	1	9	193	93	
Garant 95	980	545	455	820	400	295	1	9	205	94	
Garant 110	1100	555	547	940	407	388	2	10	287	148	
Garant 133	1336	701	580	1142	527	388	2	10	413	233	
Garant 165	1652	701	580	1459	527	382	3	11	501	298	

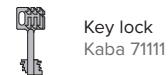

Key lock
Kaba 71111



Digital lock
Grade B (PS-600)

The outer depth is given without the handle and the lock.

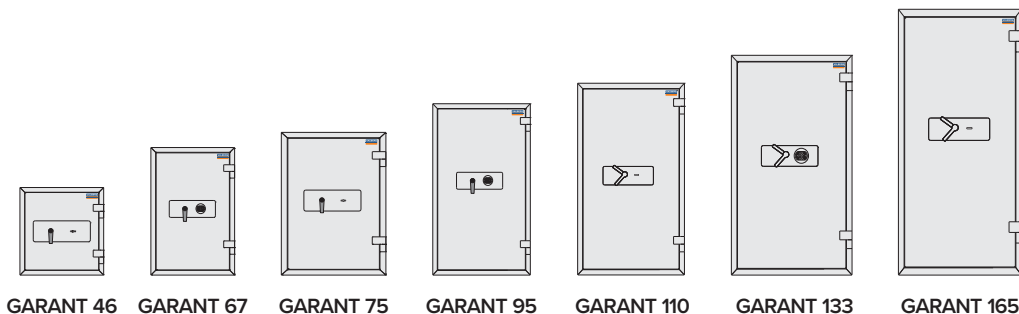

GARANT 46

GARANT 67

GARANT 75

GARANT 95

GARANT 110

GARANT 133

GARANT 165

- Burglary resistance – EN 1143-1, Grade I.
- Fire resistance – LFS 60P according to EN 15659.
- The safe body and door are manufactured with two inter-welded walls that are filled with fire resistant concrete.
- Thickness of door – 110 mm
- Thickness of walls – 80 mm
- Three way locking bolts. Double vertical bolts.
- Integrated relocker, lock secured from drill attacks.
- Standard delivery with double-bit high security key lock with two keys.
- Anchoring to the floor.
- Color: RAL 7035 (light grey), also available in RAL 7024 (grey graphite).

Innovative solutions for series Garant

VALBERG

series: **Garant**

Dead bolts
on hinge side



Double
vertical bolts



Reinforced
frame.



Multilayered wall
structure, thickness
of 80 mm



Multilayered door
structure, thickness
of 110 mm



MULTI
LAYER SYSTEM
MULTI

YOU  GOT MORE

Commercial Safes

series: **Lyon**
grade: **I, LFS 30 P**

VALBERG

YOU GOT MORE

aser
ut
ffect

MULTI
LAYER SYSTEM

a2p

LFS 30 P
ECB-S
certified

New



LYON 65

Model										
Lyon 3450	340	500	345	262	424	216	1	6	104	24
Lyon 4450	440	500	432	362	424	302	1	6	141	46
Lyon 46	460	440	430	382	364	300	1	4	135	42
Lyon 5450	540	500	432	462	424	302	1	6	167	59
Lyon 6465	638	650	550	550	574	420	2	8	262	135
Lyon 65	655	440	430	574	364	300	1	6	176	63
Lyon 8465	840	650	550	782	574	420	2	8	320	189
Lyon 90	900	440	430	822	364	300	2	9	230	90
Lyon 1065*	1041	650	554	963	574	424	2	9	388	234
Lyon 1265*	1241	650	554	1163	574	424	2	10	452	283



Key lock
Kaba 7111



Digital lock
Grade B (LG Basic)

The outer depth is given without the handle and the lock.

* Grade 1 only (no certified fire protection)

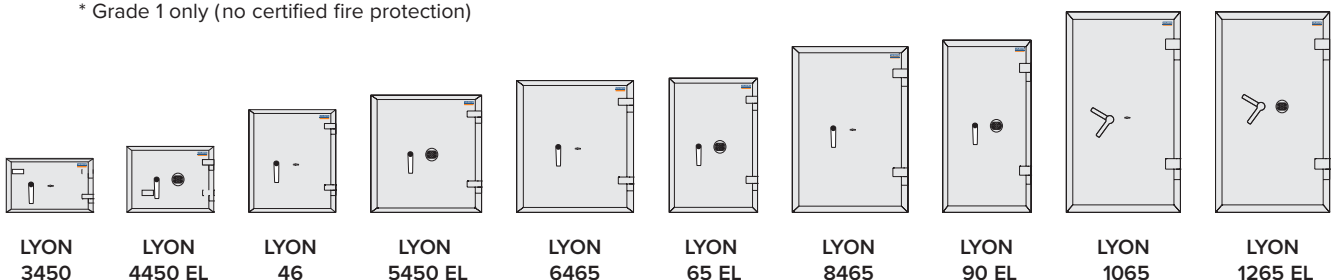

- Burglary resistance EN 1143-1, Grade I (A2P)
- Fire resistance – LFS 30P according to EN 15659.
- The safe body and door are manufactured with two inter-welded walls that are filled with fire resistant concrete.
- Three way locking bolts.
- Integrated relocker, lock secured from drill attacks.
- Standard delivery with double-bit high security key lock with two keys.
- Anchoring to the floor.
- Color: RAL 7035 (light grey), also available in RAL 7024 (grey graphite).

Commercial Safes

series: **Bastion M**
grade: **II, LFS 30 P**

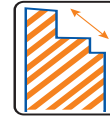
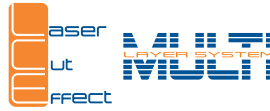

VALBERG



BASTION M 46

Model										
Bastion-M 46	460	470	470	333	355	319	1	8	179	38
Bastion-M 50	500	510	510	373	395	359	1	8	220	53
Bastion-M 67	670	510	510	544	395	359	1	8	279	77
Bastion-M 60	610	680	510	483	565	359	1	8	305	98
Bastion-M 80	810	680	510	684	565	359	2	9	382	139
Bastion-M 99	990	510	510	864	395	359	2	9	370	123
Bastion-M 1068	1010	680	510	883	565	359	2	9	419	179
Bastion-M 1368	1320	680	510	1193	565	359	3	10	572	242
Bastion-M 1668	1660	680	510	1533	565	359	4	11	755	311



Key lock
Kaba 7111



Digital lock
Grade B (PS-600)

The outer depth is given without the handle and the lock.

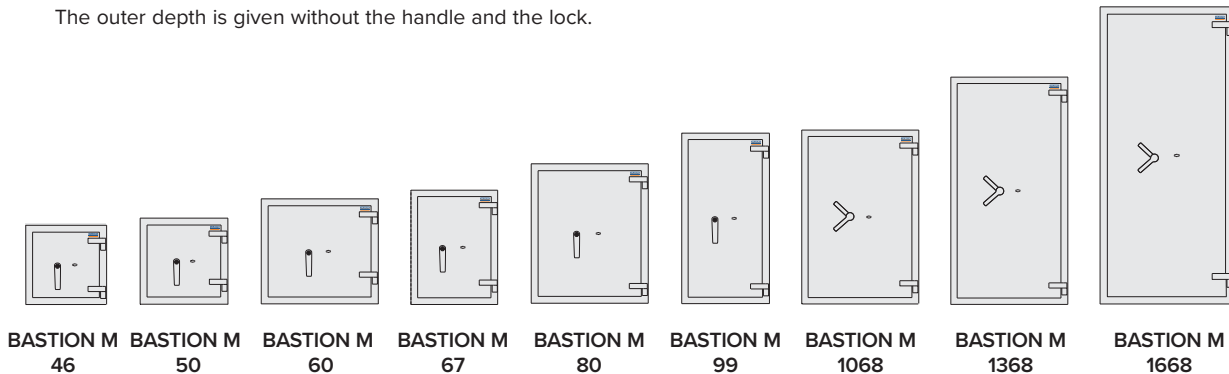

- Burglary resistance – EN 1143-1, Grade II.
- Fire resistance – LFS 30P according to EN 15659.
- Thickness of door – 92 mm.
- Thickness of walls – 58 mm.
- Patented, special type of Ultra High Performance Concrete
- Three way locking bolts.
- Integrated relocker, lock secured from drill attacks.
- Standard delivery with double-bit high security key lock with two keys.
- Anchoring to the floor and back wall.
- Color: RAL 7035 (light grey), also available in RAL 7024 (grey graphite).



Fort M Series

Commercial Safes

VALBERG

series: **Fort M**
grade: **III, LFS 30 P**



FORT M 50

Model										
Fort M 50	500	510	510	373	395	327	1	8	228	48
Fort M 60	610	680	510	483	565	327	1	8	322	89
Fort M 67	670	510	510	544	395	327	1	8	281	70
Fort M 80	810	680	510	683	565	327	2	9	396	126
Fort M 99	990	510	510	863	395	327	2	9	398	111
Fort M 1068	1010	680	510	883	565	327	2	9	478	163
Fort M 1368	1320	680	510	1193	565	327	3	10	591	220
Fort M 1385	1320	850	510	1173	715	316	3	12	782	265
Fort M 1668	1660	680	510	1513	545	316	4	11	786	261
Fort M 1685	1660	850	510	1513	715	316	4	13	941	342



Key lock
Kaba 71111



Digital lock
Grade B (PS-600)

The outer depth is given without the handle and the lock.

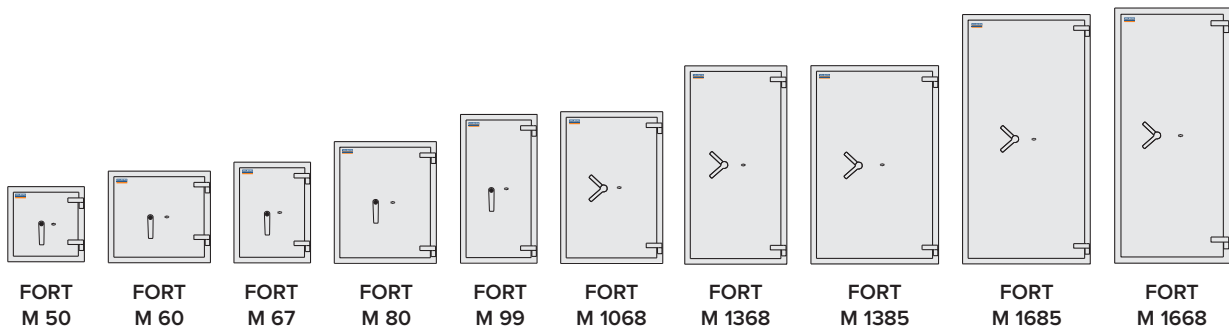

FORT M 50

FORT M 60

FORT M 67

FORT M 80

FORT M 99

FORT M 1068

FORT M 1368

FORT M 1385

FORT M 1685

FORT M 1668

- Burglary resistance – EN 1143-1, Grade III.
- Fire resistance – LFS 30P according to EN 15659.
- Thickness of door – 125 mm.
- Thickness of walls – 58 mm.
- Patented, special type of Ultra High Performance Concrete
- Three way locking bolts.
- Integrated relocker with glass plate, lock secured from drill attacks.
- Standard delivery with double-bit high security key lock with two keys.
- Anchoring to the floor and back wall.
- Color: RAL 7035 (light grey), also available in RAL 7024 (grey graphite).

Commercial Safes

series: **Banker M**
grade: **IV**

VALBERG



BANKER M 55

Model										
Banker-M 55	550	550	530	423	435	336	1	12	300	62
Banker-M 67	670	550	530	543	435	336	1	12	366	79
Banker-M 85	840	550	530	713	435	336	1	12	411	104
Banker-M 1055	1010	550	530	883	435	336	2	14	505	129
Banker-M 1568	1510	680	560	1413	545	356	3	14	900	274



Key lock
Kaba 70040 +
Kaba 70040

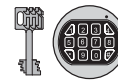

Key lock+Digital lock
Kaba 70040 +
Grade B (PS-600)

The outer depth is given without the handle and the lock.

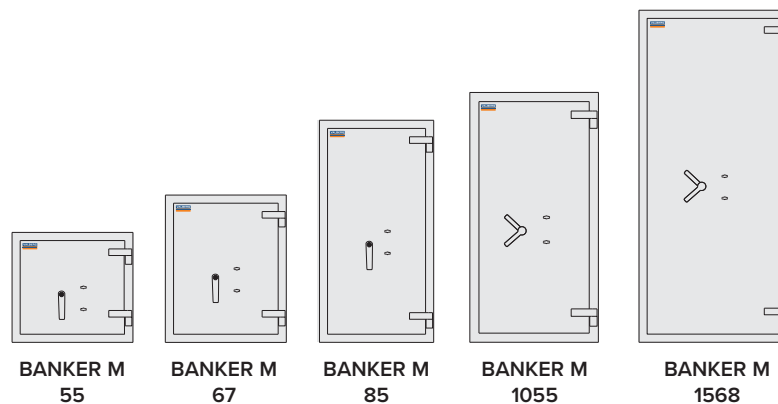

- Burglary resistance – EN 1143-1, Grade IV.
- Thickness of door – 125 mm.
- Thickness of walls – 58 mm.
- Patented, special type of Ultra High Performance Concrete
- Integrated relocker with glass plate, lock secured from drill attacks.
- Three way locking bolts.
- Standard delivery with 2 double-bit high security key locks with two keys.
- Anchoring to the floor and back wall.
- Color: RAL 7035 (light grey), also available in RAL 7024 (grey graphite).

Commercial Safes

series: **Burgas**
grade: **V, LFS 30 P**

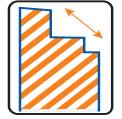

BURGAS 67



Model										
Burgas 67	680	680	630	540	540	382	1	12	600	111
Burgas 85	840	680	680	700	540	432	1	12	695	163
Burgas 1061	1010	680	680	870	540	432	2	12	808	203
Burgas 1361	1320	680	680	1180	540	432	3	14	1025	275
Burgas 1561	1510	680	680	1370	540	432	3	14	1152	320



Key lock
Kaba 70040 +
Kaba 70040



Key lock+Digital lock
Kaba 70040 +
Grade B (PS-600)

The outer depth is given without the handle and the lock.

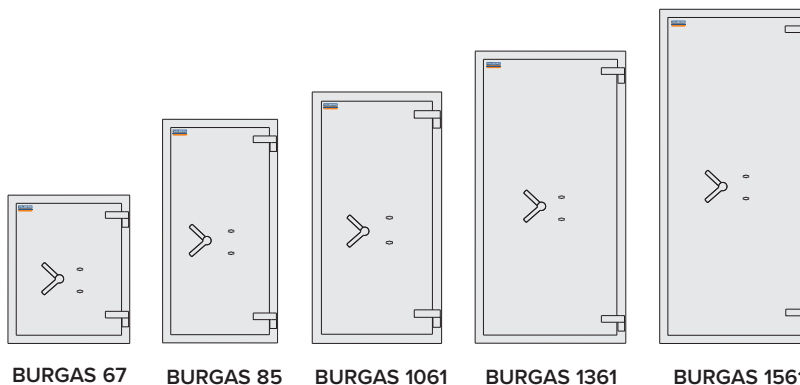

BURGAS 67

BURGAS 85

BURGAS 1061

BURGAS 1361

BURGAS 1561

- Burglary resistance – EN 1143-1, Grade V.
- Fire resistance – LFS 30P according to EN 15659.
- Thickness of door – 166 mm.
- Thickness of walls – 70 mm.
- Integrated relocker with glass plate, lock secured from drill attacks.
- Three way locking bolts.
- Standard delivery with 2 double-bit high security key locks with two keys.
- Anchoring to the floor and back wall.
- Color: RAL 7035 (light grey), also available in RAL 7024 (grey graphite).

PRIVATE SAFES



Private Safes

series: **SB**
grade: **S2**

VALBERG



MULTI
LAYER SYSTEM

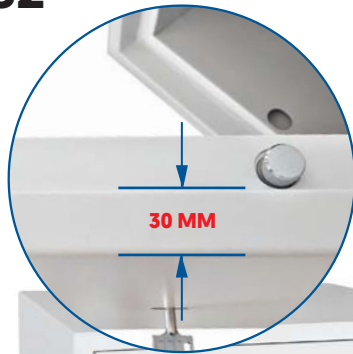

SB 300



SB 450

Model										
SB 220	220	350	300	140	270	190	1	4	15	7
SB 300	300	445	400	220	365	296	1	4	26	24
SB 450	450	445	400	370	365	296	1	4	35	40
SB 600	600	445	400	520	365	296	1	4	43	56
SB 800	800	445	400	720	365	296	2	6	55	78
SB 1000	1000	445	400	920	365	296	2	6	65	99



Key lock
Kaba 74046



Digital lock
Grade A (PS-300)

The outer depth is given without the handle and the lock.

The patented composition of the filling allows for a lower weight while maintaining the highest safety standards. Reduced weight means increased convenience of transport and assembly.



- Burglary resistance – S2 according to EN 14450.
- Thickness of door – 30 mm.
- Double-wall construction.
- Three way locking bolts.
- Lock secured from drill attacks.

- Standard delivery with double-bit high security key lock with two keys.
- Anchoring to the floor and back wall.
- Color: RAL 7035 (light grey), also available in RAL 7024 (grey graphite).

Private Safes

series: **BRF**

grade: **S2, LFS 30P**

VALBERG

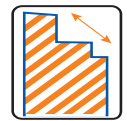

BRF 46



BRF 32

Model										
BRF-30	300	427	385	170	316	235	1	4	49	13
BRF-32	315	445	450	185	335	300	1	4	57	19
BRF-46	460	440	450	330	330	300	1	4	71	32
BRF-49	490	360	450	360	249	300	1	4	66	27
BRF-67	670	440	450	540	330	300	1	4	96	53
BRF-95	950	440	450	822	330	300	2	6	127	81



Key lock
Kaba 74046



Digital lock
Grade A (PS-300)

The outer depth is given without the handle and the lock.

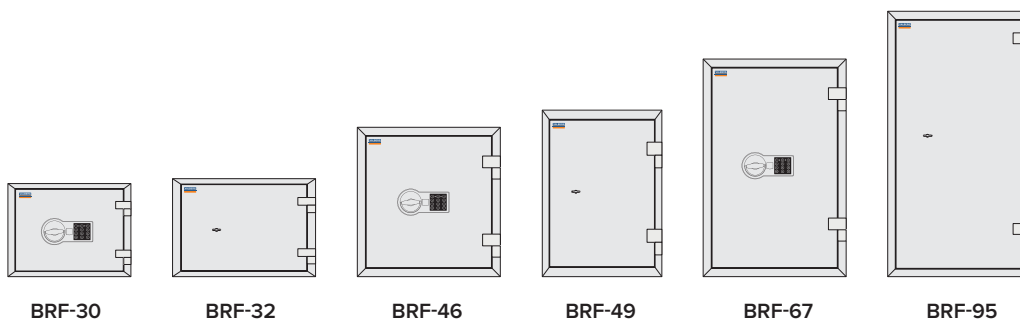

BRF-30

BRF-32

BRF-46

BRF-49

BRF-67

BRF-95

- Burglary resistance – S2 according to EN 14450.
- Fire resistance – LFS 30P according to EN 15659.
- Thickness of door - 95 mm.
- Thickness of walls - 55 mm.
- The safe body and door are manufactured with two inter-welded walls that are filled with fire resistant concrete.
- Three way locking bolts.
- Integrated relocker, lock secured from drill attacks.
- Standard delivery with double-bit high security key lock with two keys.
- Anchoring to the floor.
- Color: RAL 7035 (light grey), also available in RAL 7024 (grey graphite).

Innovative solutions for series BRF

VALBERG

series: **BRF**



Dead bolts
on hinge side



Vertical bolts



Multilayered wall
structure, thickness
of 55 mm



Thickness
of door 95 mm



Laser
Cut
Effect



Private Safes

series: **FSB**

grade: **S2, LFS 60P**

VALBERG

YOU GOT MORE

Laser
Cut
Effect

MULTI
MULTI

GRADE S2
ECB-S
certified

LFS 60 P
ECB-S
certified



**BEST
SELLER**

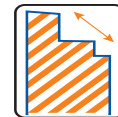

FSB 46

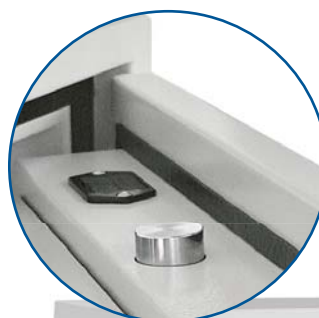

FSB 32

Model										
FSB 32	345	480	460	185	332	300	1	4	66	18
FSB 46	490	480	460	330	332	300	1	4	85	33
FSB 67	670	480	460	510	332	300	1	4	108	51



Key lock
Kaba 74046



Digital lock
Grade A (PS-300)

The outer depth is given without the handle and the lock.

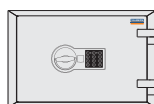

FSB 32

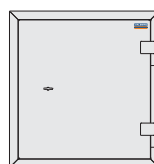

FSB 46

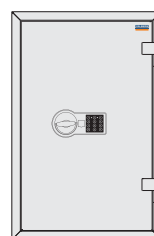

FSB 67

- Burglary resistance – S2 according to EN 14450.
- Fire resistance – LFS 60P according to EN 15659.
- Thickness of door – 105 mm.
- Thickness of walls – 77 mm.
- Thickness of rear wall – 51 mm.
- The safe body and door are manufactured with two inter-welded walls that are filled with fire resistant concrete.

- Three way locking bolts.
- Integrated relocker, lock secured from drill attacks.
- Standard delivery with double-bit high security key lock with two keys.
- Anchoring to the floor.
- Color: RAL 7035 (light grey), also available in RAL 7024 (grey graphite).

Private Safes

series: **Barrier**
grade: **0**

VALBERG



BARRIER 46

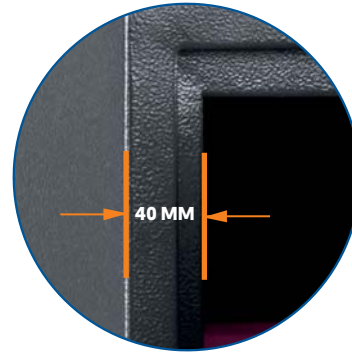

Model										
Barrier 3040*	300	400	300	214	321	165	1	4	65	11
Barrier 3045*	300	450	400	214	371	266	1	4	87	21
Barrier 45*	450	450	400	364	371	259	1	4	118	34
Barrier 3450*	340	500	300	254	421	159	1	4	87	17
Barrier 46	460	440	380	374	361	239	1	4	113	32
Barrier 67	670	440	380	584	361	239	2	4	153	50
Barrier 90	900	440	380	814	361	239	2	6	196	70



Key lock
Kaba 74046

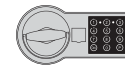

Digital lock
Grade A (PS-300)

The outer depth is given without the handle and the lock.

* Digital lock only.

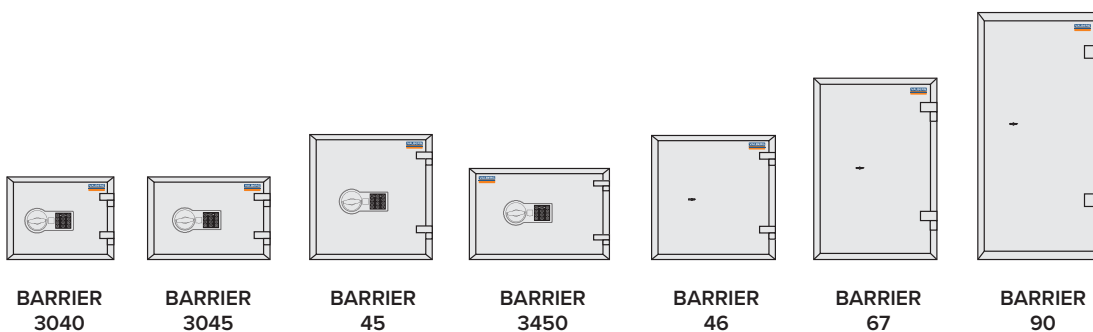

- Burglary resistance – EN 1143-1, Grade 0.
- Thickness of door – 90 mm (Barrier 3040, Barrier 3045, Barrier 45), 96 mm (all other sizes).
- Thickness of walls – 40 mm.
- Double-wall construction.
- Three way locking bolts.
- Lock secured from drill attacks.
- Standard delivery with double-bit high security key lock with two keys.
- Anchoring to the floor and back wall.
- Color: RAL 7035 (light grey), also available in RAL 7024 (grey graphite).

Private Safes

series: **ASK**

grade: **I**

VALBERG

YOU GOT MORE

Laser Cut Effect

MULTI-LAYER SYSTEM

GRADE I
IMP certified



ASK 90T



ASK 46

Model										
ASK - 20*	200	260	180	138	212	100	1	4	21	3
ASK - 25*	250	360	310	194	312	228	1	4	44	14
ASK - 30	300	440	380	244	392	298	1	4	65	29
ASK - 46	460	440	380	404	392	298	1	4	90	48
ASK - 67T	670	440	380	484	392	298	1	4	122	56/15
ASK - 90T	900	440	380	714	392	298	1	6	154	84/15



Key lock
Kaba 7111

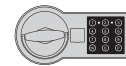

Digital lock
Grade A (PS-300)

The outer depth is given without the handle and the lock.

* No electronic lock available.

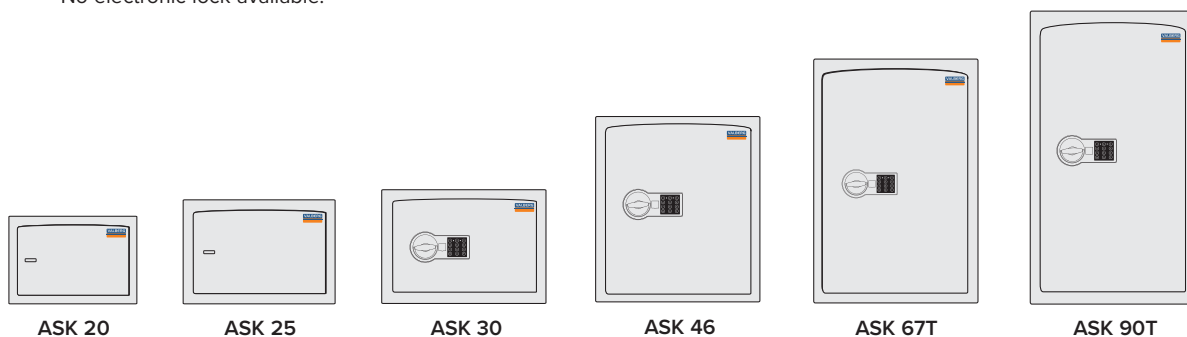

ASK 20

ASK 25

ASK 30

ASK 46

ASK 67T

ASK 90T

- Burglary resistance – EN 1143-1 IMP, Grade I.
- Increased resistance to drilling by using the front casing from solid steel - 10mm.
- Thickness of walls - 24mm.
- Three way locking bolts.
- Curved shape door vault.
- Integrated relocker, lock secured from drill attacks.
- Multilayered wall construction.
- Standard delivery with double-bit high security key lock with two keys.
- Anchoring to the floor and back wall (except ASK 67 and ASK 90)
- Color: RAL 7035 (light grey), also available in RAL 7024 (grey graphite).

Innovative solutions for series ASK

VALBERG

Thanks to the laser, it is possible to achieve the arched shape of the door vault. The most vulnerable place of the safe, the first to be exposed by the thief is the place where the door is connected to the body. The rounded shape of the door makes it difficult to effectively undermine the frame with a crowbar or other mechanical tool.

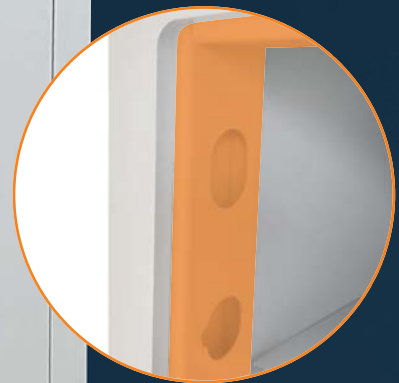

Reinforced frame.



Three way locking bolts.

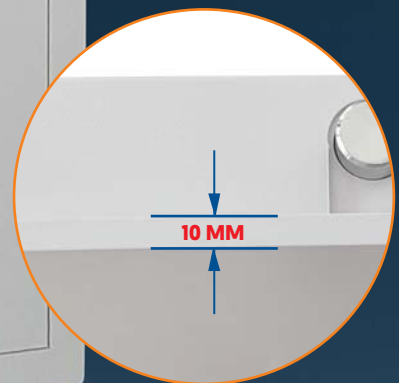

Increased resistance to drilling through the use of the front shell from solid steel 10 mm

laser
cut
effect

YOU GOT MORE

DOUBLE DOOR SAFES



Double door Safes

series: **Brandmauer**

VALBERG

YOU GOT MORE

3 LAYER
UL
EFFECT

MULTI
LAYER SYSTEM

FACTORY
30
minutes
TESTED

GRADE S2
IMP
certified



BM 1951

Model									
BM 1220	1220	930	520	1050	820	405	2	80	349
BM 1260	1220	600	520	1082	506	420	2	71	211
BM 1993	1950	930	520	1800	820	420	4	142	638
BM 1951	1950	1250	520	1800	1140	405	4	180	822



Key lock
Kaba 71111



Digital lock
Grade B (PS-600)

The outer depth is given without the handle and the lock.

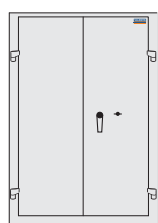

BM 1220

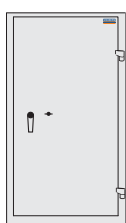

BM 1260

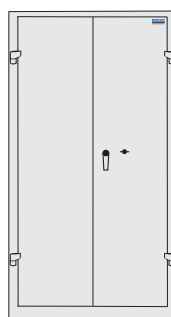

BM 1993

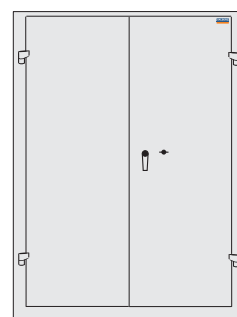

BM 1951

- Double wall construction, the gap between the inner and outer walls is filled with heat insulating material which protects the contents from fire.
- Door opening angle up to 180 degrees due to external hinges.
- Accessories: Inner compartment, telescopic shelf, telescopic frame.
- Three point locking mechanism, 5 bolts 20 mm in diameter.
- Thickness of door – 60mm.
- Standard delivery with double-bit high security key lock with two keys + handle.
- Maximal shelf load – 40 kg
- Color: RAL 7035 (light grey), also available in RAL 7024 (grey graphite).

Double door Safes

series: **FSB**
grade: **S2, LFS 60P**

YOU GOT MORE



MULTI LAYER SYSTEM

VALBERG



FSB 1993

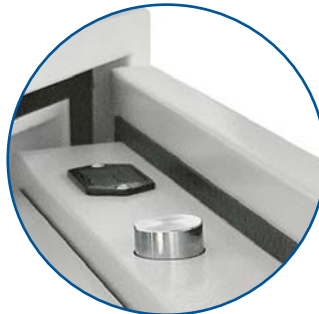

Model											
FSB 12130	1200	1250	585	1030	1110	390	2	7	440	445	
FSB 19130	1950	1250	585	1785	1110	390	4	9	650	773	
FSB 1993	1950	940	585	1760	801	392	4	9	558	553	



Key lock
Kaba 71111



Digital lock
Grade B (PS-600)

The outer depth is given without the handle and the lock.

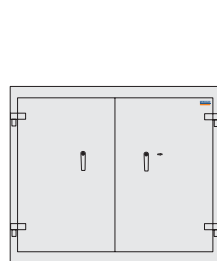

FSB 12130

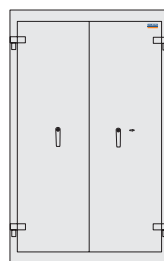

FSB 1993

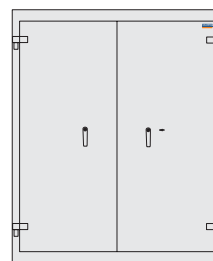

FSB 19130

- Burglary resistance – S2 according to EN 14450.
- Fire resistance – LFS 60P according to EN 15659.
- Thickness of door - 105 mm.
- Thickness of walls - 77 mm, rear wall – 51 mm.
- The safe body and door are manufactured with two inter-welded walls that are filled with fire resistant concrete.
- Maximal shelf load – 40 kg
- Three way locking bolts.
- Accessories: Inner compartment, telescopic shelf, telescopic frame.
- Integrated relocker, lock secured from drill attacks.
- Standard delivery with double-bit high security key lock with two keys.
- Anchoring to the floor.
- Color: RAL 7035 (light grey), also available in RAL 7024 (grey graphite).

Double door Safes

series: **Garant**
grade: **I, LFS 60P**

VALBERG



YOU GOT MORE



GARANT 1993

Model										
Garant 1993	1950	940	585	1760	801	392	4	13	658	553

The outer depth is given without the handle and the lock.



Key lock
Kaba 71111



Digital lock
Grade B (PS-600)

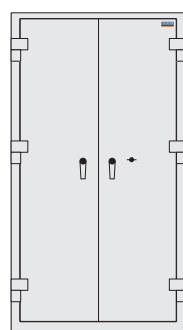

GARANT 1993

- Burglary resistance – EN 1143-1, Grade I.
- Fire resistance – LFS 60P according to EN 15659.
- The safe body and door are manufactured with two inter-welded walls that are filled with fire resistant concrete.
- Thickness of door – 110 mm
- Thickness of walls – 80 mm
- Accessories: Inner compartment, telescopic shelf, telescopic frame.
- Three way locking bolts. Double vertical bolts.
- Integrated relocker, lock secured from drill attacks.
- Standard delivery with double-bit high security key lock with two keys.
- Maximal shelf load – 40 kg
- Anchoring to the floor.
- Color: RAL 7035 (light grey), also available in RAL 7024 (grey graphite).

DEPOSIT SAFES



Deposit Safes

series: **ASD**

grade: **S1**

VALBERG



ASD 19 EL



ASD 32 EL

Model										
ASD 19	489	342	381	464	330	317	218x110x60		31	50
ASD 32	812	419	427	796	407	336	296x110x60		55	155



Key lock
Kaba 74046

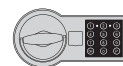

Digital lock
Grade A (PS-300)

The outer depth is given without the handle and the lock.

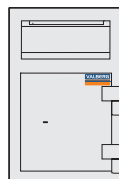

ASD 19

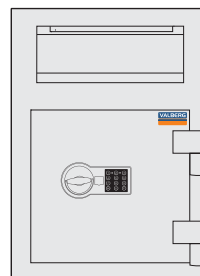

ASD 32

- Burglary resistance – Grade S1 according to EN 14450.
- Doors secured with solid steel plate.
- Single wall body.
- Three way locking bolts.
- Anti-fishing protection.
- Standard delivery with double-bit high security key lock with two keys.
- Color: RAL 7035 (light grey), also available in RAL 7024 (grey graphite).

Deposit Safes

series: **DSC**
grade: **DI**

VALBERG



MULTI
LUXURY SYSTEMS



DSC 67



DSC 67

Model											
DSC 65	670	440	550	448	364	423	104-308-124	1	6	192	69/4
DSC 67	670	650	550	455	573	423	104-517-124	-	6	248	100/7
DSC 80	840	650	550	616	573	423	104-517-124	1	8	290	149/7
DSC 100	1040	650	550	816	573	423	104-517-124	2	9	350	198/7
DSC 120	1240	650	550	1016	573	423	104-517-124	2	10	410	246/7



Key lock
Kaba 7111



Digital lock
Grade B (PS-600)

The outer depth is given without the handle and the lock.

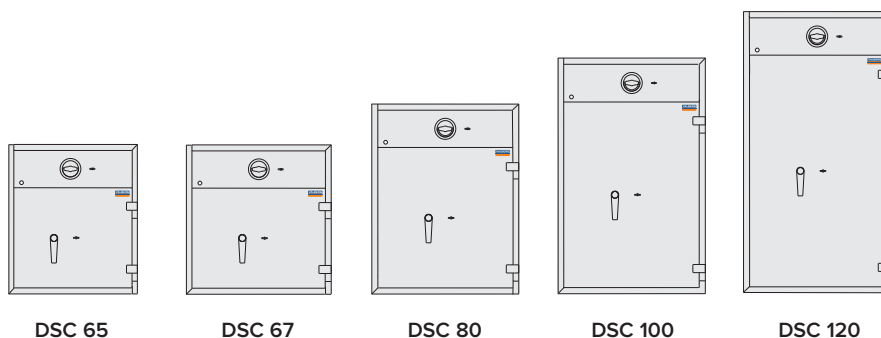

DSC 65

DSC 67

DSC 80

DSC 100

DSC 120

- Burglary resistance – D-I grade (EN 1143-2, ECB-S).
- Thickness of door – 85 mm.
- Thickness of walls – 40 mm.
- Three way locking bolts.
- Integrated relocker, lock secured from drill attacks.
- Possible to equip the deposit drawer with grade B electronic lock.
- Drawer closed bolt system
- Standard delivery with double-bit high security key lock with two keys.
- Anti-fishing device.
- Anchoring to the floor.
- Color: RAL 7035 (light grey), also available in RAL 7024 (grey graphite).

Innovative solutions for series DSC

VALBERG

series: **DSC**



Reinforced
with bolts

Anti-fishing
system



MULTI
LAYER SYSTEM
MULTI

GUN SAFES



Gun Safes

series: **Arsenal**
grade: **S1**

VALBERG



ARSENAL 1433



Equipped with an inner compartment



Solid body and door construction provides high resistance for cutting



ARSENAL 1253



Model											
Arsenal 1253	1250	545	345	1244	539	295	240-200-245	1000	6	83	
Arsenal 1423	1450	210	280	1444	204	230	145-204-195	1295	3	43	
Arsenal 1433	1450	255	345	1444	249	295	145-249-265	1295	5	55	
Arsenal 1443	1450	375	345	1444	369	295	145-369-265	1295	7	68	

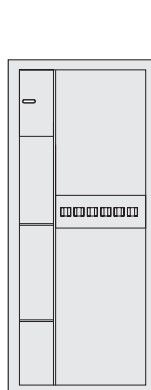
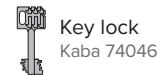

ARSENAL 1253

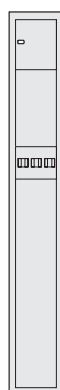

ARSENAL 1423



ARSENAL 1433

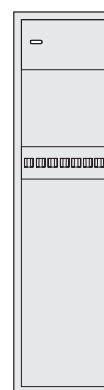

ARSENAL 1443

- Burglary resistance – EN 14450, Grade S1.
- Three way locking bolts.
- Integrated relocker, lock secured from drill attacks.
- Standard delivery with double-bit high security key lock with two keys.
- Color: RAL 7035 (light grey), also available in RAL 7024 (grey graphite).

New



ASG/WS Series

Gun Safes

series: **ASG/WS**
grade: **I**

VALBERG



YOU GOT MORE



Inner compartment
as an option



ASG/WS5

Model										
ASG/WS3*	1345	310	375	1240	205	244	1215	3	6	108
ASG/WS5	1515	400	385	1400	285	232	1273	5	7	160
ASG/WS6	1650	460	450	1530	340	300	1336	6	7	205
ASG/WS8	1650	570	450	1530	450	300	1336	8	7	235
ASG/Combi	1650	850	450	1530	730	300	1336	5/5	9	325
ASG/WS14	1650	880	450	1530	760	300	1336	14	9	325



Key lock
Kaba 71111



Digital lock
Grade B (PS-600)

The outer depth is given without the handle and the lock.
* Grade 1 only (no certified fire protection)

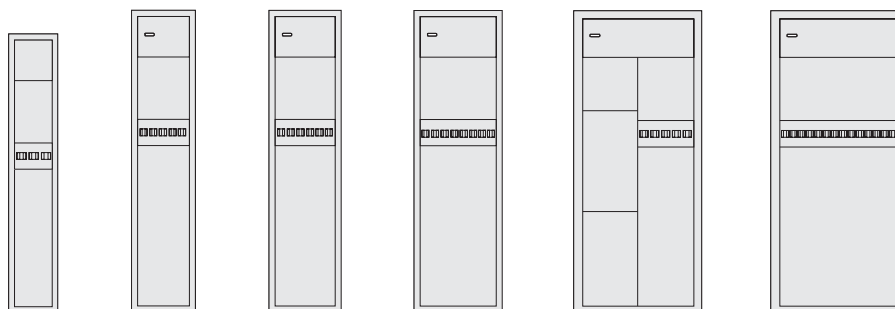

ASG/WS3

ASG/WS5

ASG/WS6

ASG/WS8

ASG/COMBI

ASG/WS14

- Burglary resistance – EN 1143-1, Grade I.
- Fire resistance – LFS 30P according to EN 15659.
- Thickness of door 95 mm, thickness of walls 55 mm.
- The safe body and door are manufactured with two inter-welded walls that are filled with fire resistant concrete.
- Three way locking bolts.
- Integrated relocker, lock secured from drill attacks.
- Standard delivery with double-bit high security key lock with two keys.
- Anchoring to the floor or to the wall.
- Color: RAL 7035 (light grey), also available in RAL 7024 (grey graphite)..

FIRE RESISTANT SAFES



Fire Resistant Filing Cabinets

VALBERG

series: **FC**
grade: **LFS 60P**

aser
ut
ffect

MULTI
LAYER SYSTEM

LFS 60 P
ECB-S
certified



Optional wheels available

Model									
FC 1	487	480	653	250	326	512	1	78	
FC 2	825	545	653	250	390	500	2	110	
FC 3	1163	545	653	250	390	500	3	150	
FC 4	1500	545	653	250	390	500	4	210	



Key lock



Digital lock



Combination lock

The outer depth is given without the handle and the lock.
The outer height is given without wheels. The height with wheels is +20 mm

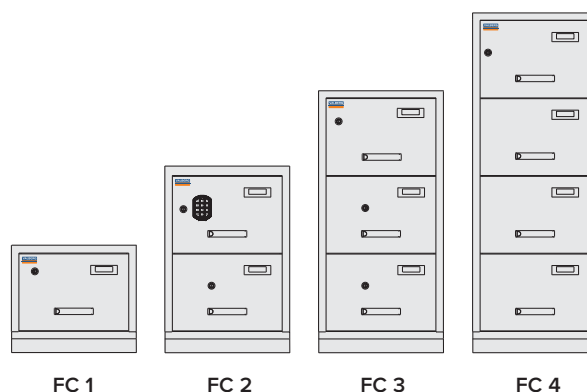

- Fire resistance – 1 hour LFS 60P according to EN 15659.
- Drawer capacity – 50 kg.
- Drawers adjustable for A4 and Foolscap files.
- Electrostatic powder coating is applied to all sides including the bottom. The finish is scratch-resistant providing a lifetime quality appearance.
- Individual drawer locking allows the user to leave one or more drawers unlocked with the push lock in the locked position.
- All filing cabinets are installed with a central high security key or digital push lock. Additional drawers can be installed with key, digital or mechanical combination locks. Key lock made in Germany (Euro Locks).
- Anti-tilt device.
- Handles and label holders are made of rubber coated plastic (soft touch).
- Color: RAL 7035 (light grey), also available in RAL 7024 (grey graphite).

Fire Resistant Safes

VALBERG

series: **FRS**
grade: **LFS 60P**

YOU GOT MORE



FRS 30



FRS 133



Optional wheels available

Model										
FRS 30	296	430	365	188	326	236	-	tray	31	15
FRS 32	315	445	425	207	341	296	-	tray	38	21
FRS 49	490	361	425	382	257	296	-	1+tray	46	29
FRS 51	510	445	425	402	341	296	-	1+tray	54	41
FRS 66	653	485	450	467	346	301	85x343	1	75	49
FRS 67	713	485	450	527	346	301	85x343	1	86	49
FRS 75	792	485	450	607	346	301	85x343	1	103	64/8
FRS 93	972	565	450	786	426	301	85x423	2	138	98/10
FRS 120	1249	711	580	1034	546	418	135x515	2	290	236/26
FRS 133	1363	711	580	1170	546	418	135x515	2	332	267/26
FRS 165	1700	711	580	1487	546	418	135x515	3	390	340/26

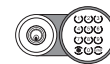

Digital lock + Key lock



Digital lock + Thumbturn

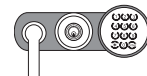

Digital lock + Key lock

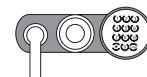

Digital lock + Handle

The outer depth is given without the handle and the lock.

The outer height is given without wheels. The height with wheels is +20 mm

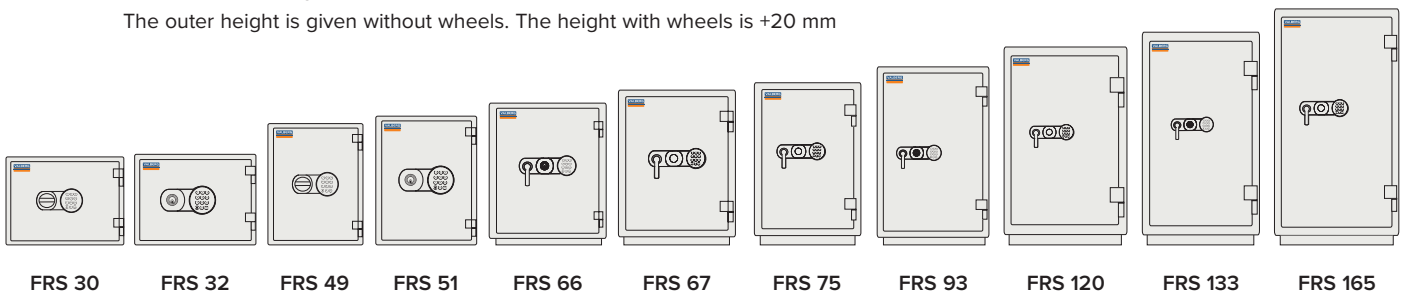

FRS 30

FRS 32

FRS 49

FRS 51

FRS 66

FRS 67

FRS 75

FRS 93

FRS 120

FRS 133

FRS 165

- Fire resistance – LFS 60P according to EN 15659.
- The safe body and door are manufactured with two inter-welded walls that are filled with fire resistant concrete.
- Dead bolts on hinge side
- The thickness of wall 50 mm.

- The thickness of door 95 mm.
- Pull out tray or drawer included.
- Anchoring to the floor.
- Color: RAL 7035 (light grey), also available in RAL 7024 (grey graphite).

Innovative solutions for series FRS

VALBERG

series: **FRS**



Dead bolts
on hinge side



Pull out tray

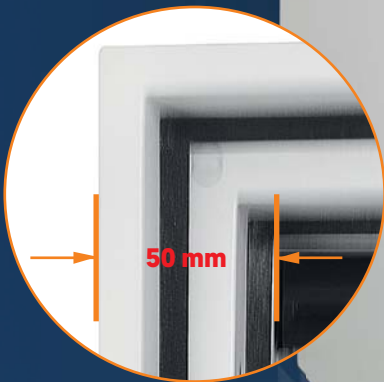

Multilayered wall
structure, thickness
of 50 mm



Pull out drawer



Multilayered door
structure, thickness
of 95 mm



New



FRS **PLUS** Series

Fire Resistant Safes

VALBERG

series: **FRS PLUS**
grade: **NT FIRE 90P**

YOU GOT MORE

New

Laser Cut Effect

MULTI LAYER SYSTEM

SP Certified

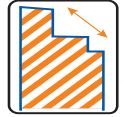

FRS 32 PLUS



FRS 51 PLUS

Model									
FRS 30 PLUS	300	405	355	190	305	219	tray	28	13
FRS 32 PLUS	315	430	430	205	330	296	tray	37	20
FRS 36 PLUS	360	480	430	250	380	294	tray	48	28
FRS 49 PLUS	490	350	430	380	250	294	1+tray	48	28
FRS 51 PLUS	490	430	430	380	330	295	1+tray	50	37

The outer depth is given without the handle and the lock.

Digital lock + Key lock

Digital lock + Thumbturn

Digital lock + Key lock

Digital lock + Handle

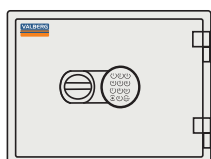

FRS 30

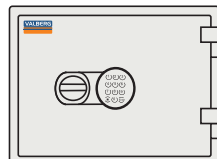

FRS 32

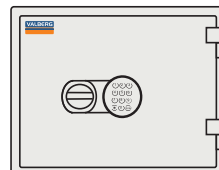

FRS 36

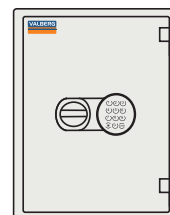

FRS 49

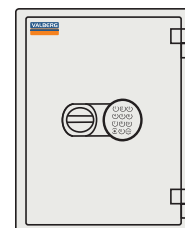

FRS 51

- Fire resistance – NT FIRE 90P
- The safe body and door are manufactured with two inter-welded walls that are filled with fire resistant concrete.
- Modern design
- Dead bolts on hinge side
- The thickness of wall 50 mm.
- The thickness of door 85 mm.
- Pull out tray included.
- Anchoring to the floor.
- Color: RAL 7035 (light grey), also available in RAL 7024 (grey graphite).

VAULT DOORS



Vault Doors

series: **AVD**
grade: **III, V**

VALBERG



- Burglary resistance – grade III or V according to EN-1143/1 standard.
- Ideal for securing anything from artworks to national bank vaults.
- Designed to be set into concrete walls
- Ultra high density, reinforced concrete core with steel cladding
- All doors come with two class II/B locks as standard
- Locks on doors are located on the outside only
- Can be supplied with key, mechanical combination or electronic locks. Electronic locks offer many advantages: dual code, time delay, opening window, wrong code lockout
- All doors have external hinges and can only open outwards. They will all open 180° where the surrounding building allows it
- Option: an emergency door which can be used in the event that the main door cannot be operated

Innovative solutions for series AVD

VALBERG

grade: III, V



Grill door



Emergency door

Vault Doors

series: **AVD**
grade: **III,V**

VALBERG

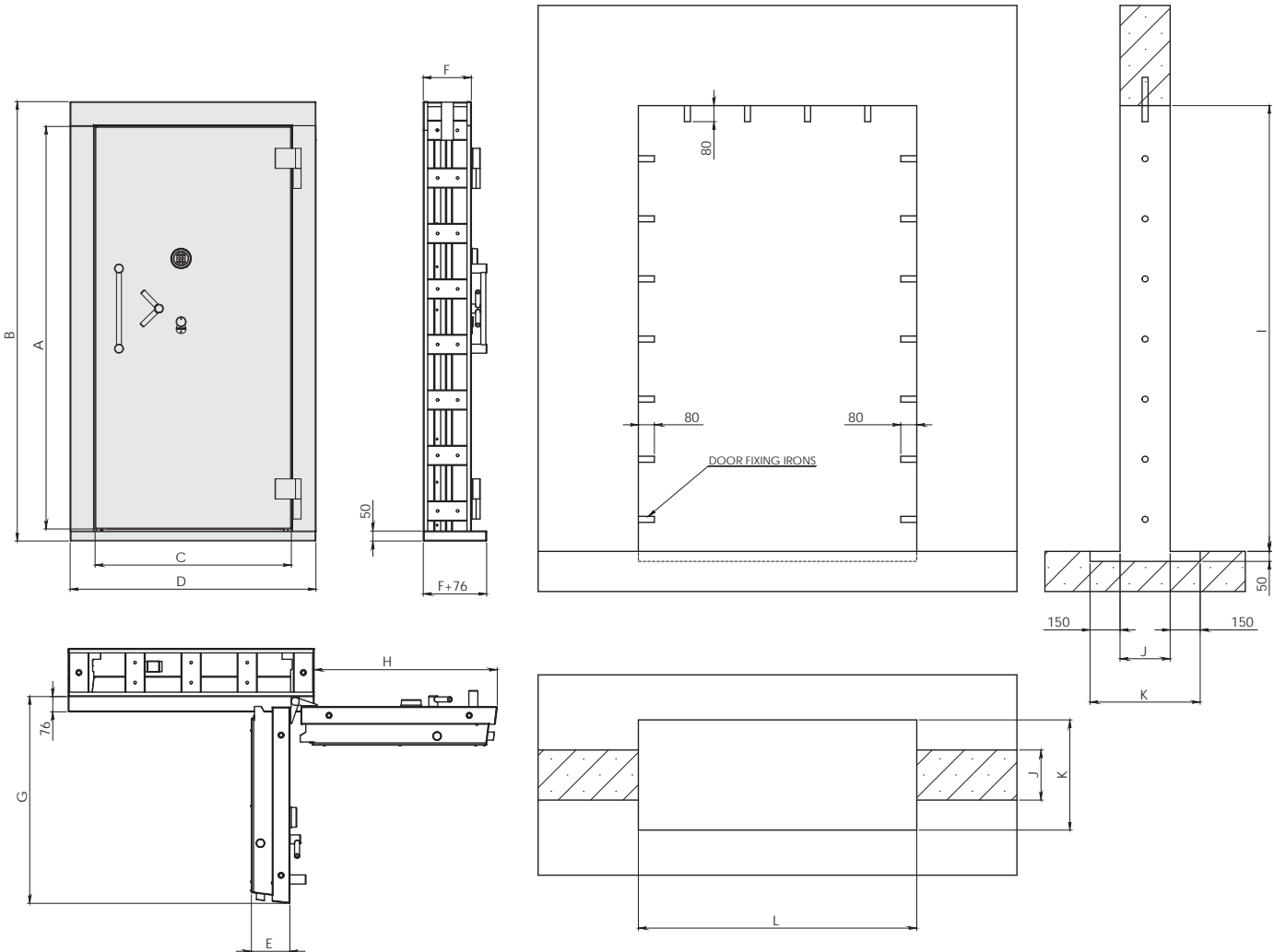

Model	Grade	Dimensions, mm												Free clearance	Weight kg
		A	B	C	D	E	F	G	H	I	J	K	L		
AVD 3	III	2010	2019	980	1227	192	240	1032	914	2350	240	240	1480	2000x900	720
AVD 5	V														800

FURNITURE SAFES



Furniture Safes

VALBERG

series: T



T 170

T 140



T 230



T 280

Model										
T 140	140	195	140	138	193	95	-	3	2.5	
T 170	170	260	230	168	258	185	-	5	8	
T 200	200	310	200	198	308	155	-	5.5	9	
T 230	230	310	250	228	308	205	-	6.5	14	
T 250	250	350	250	248	348	205	-	7	18	
T 280	280	350	300	278	348	255	1	8	25	

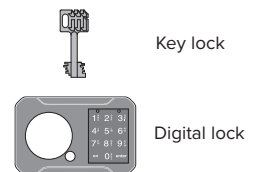

The outer depth is given without the handle and the lock.

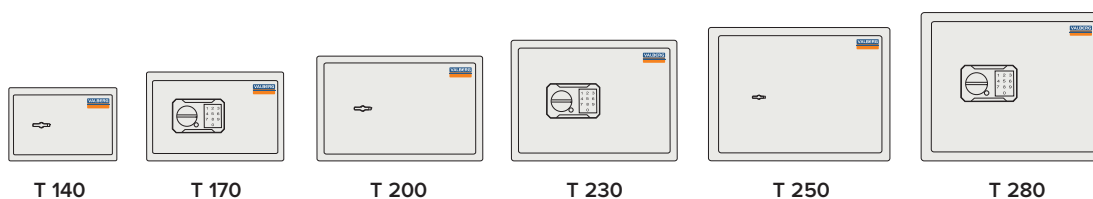

- Single-walled furniture safes.
- Steel thickness of front panel – 2,8 mm.
- Steel thickness of walls – 1,2 mm.
- Anchoring to the floor and back wall.
- Color: RAL 7035 (light grey), also available in RAL 7024 (grey graphite).

TECHNICAL INFORMATION



Locks, Dials, Keypad

SAFES AND LOCKS COMPATIBILITY MATRIX



MODEL	PS 300 / PS 310	PS 600 / PS 610 / PS 650	LG Basic/ M Locks EM2020/2050/ Wittkopp Primor 1000	Code Combi B 30	Code Combi B 30 x 2
SB	+				
Barrier	+				
Bastion M		+	+	+ (except Bastion M 46)	+ (except Bastion M 46 and Bastion M 50)
Fort M		+	+	+	+ (except Fort M 50 and Fort M 60)
Banker M		+	+	+ (+KL)	+ (except Banker M 55)
Burgas		+	+	+ (+KL)	+
BRF	+				
FSB (32/46/67)	+				
FSB Double Door		+	+		
Lyon		+	+	Only Lyon 6465, 8465, 1065, 1265	
ASG/WS		+	+		
Garant		+	+	+	Only Garant 1993
Granit		+	+	Only Granit 6465, 8465, 1065, 1265	
DSC		+	+		
ASD	+				
Arsenal	+				
ASK	+ (except ASK 20 and ASK 25)	Only ASK 90	Only ASK 90		
Brandmauer	+	+	+		

* Acceptable weight tolerance +/-10%.







The producer reserves the right for minor changes of weight, colour and dimensions of products without prior notice. The changes can be of different nature. However all the efforts should be made to ensure that the information in this catalog is most accurate. For details please contact our official distributors. Product dimensions do not include the dimensions of locks and handles.

Locks, Dials, Keypad

LOCK FUNCTIONS SUMMARY

FUNCTIONS	PS 300	PS 310	PS 550	PS 600	PS 610	PS 650
						
SECURITY LEVEL, ECB-S, EN 1300	A	B	A	B	B	B
MASTER CODE	1	1	1	1	1	1
USER CODE	1	9	9	1	9	9
DUAL CODE	-	+	-	+	+	+
TIME DELAY (0-99 MIN.)	+	+	+	+	+	+
OPENING WINDOW (1-9 MIN.)	+	+	+	+	+	+
TIME DELAY OVERRIDE	-	-	-	-	-	-
WRONG CODE LOCKOUT	+	+	+	+	+	+
ATTACK ALARM	-	-	-	-	-	-
CONNECT TO ALARM	-	-	-	-	-	-
AUDIT OPENING ID	-	-	-	-	-	-
EMERGENCY KEY	-	-	-	-	-	+

Locks, Dials, Keypad

Locks	Grade	KEYPAD					
							
		E01	E02	E05	E31	E36	E33
	A	x	x		x		
PS300							
	B	x	x		x		
PS310							
	B	x Boltwork M3/ M6 + handle	x Boltwork M3/ M6 + handle		x Boltwork M3/ M6 + handle		x Boltwork M3/ M6 + handle
PS550							
	B			x Boltwork M3/ M6 + handle	x Boltwork M3	x Boltwork M3/ M6 + handle	
PS600							
	B			x Boltwork M3/ M6 + handle	x Boltwork M3	x Boltwork M3/ M6 + handle	
PS610							
	B						x Boltwork M3/ M6 + handle
PS650							
	A B						
LG/Sargent							

Transport information

PRODUCTS ON PALLET

MODEL	Type of pallet	Quantity on the pallet
ASD 19	1x1.2	18
ASD 32	1x1.2	6
ASG WS/3	1x1.2	6
ASG WS/5	1x1.2	4
ASG WS/6	1x1.2	4
ASG WS/8	1x1.2	4
ASG/combi	1x1.2	2
ASG WS/14	1x1.2	2
BANKER M 1055	0.8x1.2	1
BANKER M 1255	0.8x1.2	1
BANKER M 1285	0.8x1.2	1
BANKER M 1368	0.8x1.2	1
BANKER M 1568	0.8x1.2	1
BANKER M 55	0.8x1.2	2
BANKER M 67	0.8x1.2	2
BANKER M 85	0.8x1.2	2
BARRIER 1265	0.8x1.2	2
BARRIER 3040	0.8x1.2	14
BARRIER 3045	1x1.2	12
BARRIER 3450	0.8x1.2	12
BARRIER 45	1x1.2	8
BARRIER 46	1x1.2	8
BARRIER 6465	0.8x1.2	2
BARRIER 67	1x1.2	8
BARRIER 8465	0.8x1.2	2
BARRIER 90	0.8x1.2	2
BASTION M 100	0.8x1.2	2
BASTION M 46	0.8x1.2	3
BASTION M 50	0.8x1.2	3

MODEL	Type of pallet	Quantity on the pallet
BASTION M 60	0.8x1.2	2
BASTION M 80	0.8x1.2	2
BASTION M 1068	0.8x1.2	2
BASTION M 1368	0.8x1.2	2
BASTION M 1585	0.8x1.2	1
BASTION M 1668	0.8x1.2	2
BASTION M 67	0.8x1.2	2
BASTION M 99	0.8x1.2	2
BM 1220	1x1.2	2
BM 1260	0.8x1.2	3
BM 1951	1.2x1.3	2
BM 1993	1x1.2	2
BRF 30	1x1.2	16
BRF 32	1x1.2	16
BRF 46	1x1.2	12
BRF 49	1x1.2	18
BRF 67	1x1.2	8
BRF 95	1x1.2	6
BURGAS 1061	0.8x1.2	1
BURGAS 1361	0.8x1.2	1
BURGAS 1561	0.8x1.2	1
BURGAS 67	0.8x1.2	1
BURGAS 85	0.8x1.2	1
DSC 100	0.8x1.2	2
DSC 120	0.8x1.2	2
DSC 67	0.8x1.2	2
DSC 80	0.8x1.2	2
FC 1	0.8x1.2	2
FC 2	0.8x1.2	2

Transport information

PRODUCTS ON PALLET

MODEL	Type of pallet	Quantity on the pallet
FC 3	0.8x1.2	2
FC 4	0.8x1.2	2
FORT M 1068	0.8x1.2	2
FORT M 1285	0.8x1.2	1
FORT M 1368	0.8x1.2	2
FORT M 1385	0.8x1.2	1
FORT M 1566	0.8x1.2	1
FORT M 1585	0.8x1.2	1
FORT M 1668	0.8x1.2	1
FORT M 1685	0.8x1.2	1
FORT M 50	0.8x1.2	2
FORT M 60	0.8x1.2	2
FORT M 67	0.8x1.2	2
FORT M 80	0.8x1.2	2
FORT M 99	0.8x1.2	2
FRS 120	0.8x1.2	2
FRS 133	0.8x1.2	2
FRS 165	0.8x1.2	2
FRS 30	0.8x1.2	24
FRS 32	0.8x1.2	20
FRS 49	1x1.2	18
FRS 51	1x1.2	12
FRS 66	0.8x1.2	6
FRS 67	0.8x1.2	6
FRS 75	0.8x1.2	6
FRS 85	0.8x1.2	6
FRS 93	1x1.2	4
FRS 30 PLUS	1x1.2	18
FRS 32 PLUS	1x1.2	18

MODEL	Type of pallet	Quantity on the pallet
FRS 36 PLUS	1x1.2	18
FRS 49 PLUS	1x1.2	18
FRS 51 PLUS	1x1.2	12
FSB 12130	0.7x1.3	1
FSB 19130	0.7x1.3	1
FSB 1993	0.8x1.2	1
FSB 32	1x1.2	12
FSB 46	1x1.2	8
FSB 67	1x1.2	8
GARANT 110	0.8x1.2	2
GARANT 133	0.8x1.2	2
GARANT 165	0.8x1.2	2
GARANT 1993	0.8x1.2	1
GARANT 46	1x1.2	8
GARANT 67	1x1.2	6
GARANT 75	0.8x1.2	2
GARANT 95	1x1.2	4
GRANIT 1065	0.8x1.2	2
GRANIT 1265	0.8x1.2	2
GRANIT 3450	0.8x1.2	8
GRANIT 4450	1x1.2	6
GRANIT 46	1x1.2	8
GRANIT 5450	1x1.2	6
GRANIT 6465	0.8x1.2	2
GRANIT 65	1x1.2	6
GRANIT 8465	0.8x1.2	2
GRANIT 90	1x1.2	4
GS 1253	0.8x1.2	4
GS 1423	0.8x1.2	10

Transport information

PRODUCTS ON PALLET

MODEL	Type of pallet	Quantity on the pallet
GS 1433	0.8x1.2	8
GS 1443	0.8x1.2	6
SB 1000	1x1.2	6
SB 220	0.8x1.2	42
SB 290	0.8x1.2	36
SB 300	0.8x1.2	20
SB 350	1x1.2	30
SB 450	1x1.2	16
SB 550	1x1.2	16
SB 600	1x1.2	8
SB 800	1x1.2	8
T 140	1x1.2	100
T 170	1x1.2	96
T 200	0.8x1.2	30
T 230	0.8x1.2	50
T 250	0.8x1.2	30
T 280	0.8x1.2	30

FULL TRUCK QUANTITY:

MODEL	Quantity in a full truck
ASG/WS 3	156
ASG/WS 5	104
BM 1220	78
BM 1260	120
BM 1993	52
BM 1951	40
FSB 12130	30
FSB 19130	30
FSB 1993	33
GARANT 1993	30

SECURITY LEVELS AND INSURANCE AMOUNTS

Security Levels	Symbol	Description	Resistant Unit	Amount Insured (without EMA)	
				Private Use	Commercial Use
ECB-S / VdS (according to EN 1143-1; EN 14450)					
S1		Security Cabinet	40 TP / 2 SU EN14450	max. 5 000 €	non-insurable
S2		Security Cabinet	60 TP / 5 SU EN14450	max. 20 000 €	max. 2 500 €
0		Safe	30 RU EN 1143-1	max. 40 000 €	max. 10 000 €
I		Safe	30/50 RU EN 1143-1	max. 65 000 €	max. 20 000 €
II		Safe	50/80 RU EN 1143-1	max. 100 000 €	max. 50 000 €
III		Safe	80/120 RU EN 1143-1	max. 200 000 €	max. 100 000 €
IV		Safe	120/180 RU EN 1143-1	max. 400 000 €	max. 150 000 €
V		Safe	180/270 RU EN 1143-1	negotiable / keine Empfehlung	max. 250 000 €
D-I		Deposit Safe	30/50 RU EN 1143-2	max. 65 000 €	max. 20 000 €
FIRE PROTECTION GRADES					
Fire Protection Grade	Symbol	Description	Certification Standard	Maximum Temperature in the Safe	
LFS 30 P		Light Fire Protection 30 Minutes	EN 15659	170° C	
LFS 60 P		Light Fire Protection 1 hour	EN 15659	170° C	
NT FIRE 017 - 90 Paper		Fire Protection 90 Minutes Paper	NT Fire 017	170° C	

All safes with fire protection are certified in accordance with ECB-S and NT Fire. Tested in Germany and Sweden.

GENERAL TERMS AND CONDITIONS OF BUSINESS OF PROMET SAFE

1. General provisions and scope of application of these GTC All deliveries, services and offers to our customers are made solely on the basis of these General terms and Conditions of Business (GTC). We shall not accept terms and conditions from the customer, which conflict with or differ from our Terms and Conditions. They will also not be accepted if we do not explicitly reject them after receipt. Deviations from these General terms and Conditions at our account are only effective if they are confirmed by us in writing.

2. Offer and contract conclusion

All orders directed to us require our written confirmation to become effective. The content of our confirmation is solely applicable. Drawings, illustrations, dimensions, weights and other performance data are only binding if this is explicitly agreed upon in writing.

3. Partial deliveries

We explicitly reserve the right to make partial deliveries in as much as this is reasonable, taking the interests of the buyer into consideration.

4. Prices Value-added tax to be added.

The prices quoted by the seller refer exclusively to the goods, performances and other services quoted in the offer. If the purchaser wants to deviate from them, then the seller will adjust prices accordingly.

5. Contract conclusion

After a time period of six weeks after contract conclusion, the seller is entitled to adjust the prices for the following reasons:

- a) Significant changes in the exchange rate for imported goods or special taxes and fees, which are charged by law.
- b) Increases in costs due to official administrative measures.
- c) Increases of labor costs and increased material costs.
- d) Increased transportation costs (if freight is included in the price of the offer)
- e) Accelerated delivery as well as any additional requests by the customer to which the seller agrees, such as changes of delivery instructions and times of availability, quantities, format, or similar specifications in reference to goods, performances and other services.
- f) Delays, for which the purchaser is responsible as a result of his instructions or failure to provide the required instructions.

6. Delivery

Delivery is made by freight, mail or rail for the account and risk of the purchaser; the purchaser carries the risk even if post paid delivery is agreed upon. The goods are not insured by the seller. Any damage during transport must be immediately reported to the freight Company, postal agency or rail agency. For required transport to different stories (steps up or down as well as transport over steps into buildings) consult our transport service.

7. Delivery and time of performance

The delivery dates and times of performance noted by us are strictly non-binding. The time of delivery for ordered goods starts from the day of the order confirmation and ends the day the goods leave the company. If the customer requires changes after receipt of our order confirmation, then the time of delivery starts only after our written confirmation of the change order. We are authorized to make partial deliveries and partial services. Acts beyond our control authorize us to delay the delivery or service for the duration of the hindrance or to withdraw in full or in part from noncompleted parts of the contract. Acts beyond our control include all circumstances which significantly complicate the delivery / performance or which make it impossible, such as sovereign measures, strikes, lock-outs, operational problems (such as fire, lack of energy) as well as restrictions of transportation routes, regardless if these occurrences happen with us, the delivery plant, a transport carrier or a third party. In this case, the customer can request an explanation, if we intend to withdraw or if we will be able to deliver within a certain suitable time frame. The customer may withdraw after a statutory time period as required by law insofar the goods/services are not reported to be ready to be shipped or be met by the deadline.

8. Payment

The amount of the invoice is payable net within 30 days from the invoice date or within 8 days from the invoice date with a 2% discount insofar payment in cash without discount has not been agreed upon. For payment delay, 12% interest is charged. This also applies for partial deliveries.

9. Warranties

The seller reserves the right for any deviations from the dimensions or construction changes or parts of construction. The same applies correspondingly to all services and other performances. Weight data is provided as exact as possible, but non-binding. The customer must check the goods immediately for obvious deficiencies. Externally recognizable transport damage must be confirmed immediately by the freight deliverer, according to insurance regulations. The reporting time frame for hidden damage is 3 days from acceptance of the goods. Obvious deficiencies must be reported in writing immediately after receipt of the goods, hidden deficiencies within a week after discovery of the deficiency. For valid deficiencies, we provide repair or new delivery free of charge, at our option. The warranty period as set forth by law is 24 months. If the warranty provision provided by us fails within a fair grace period, a request for a price reduction or rescission of the contract can be made. Additional warranties and/or claims for indemnities for what ever legal reason are excluded, unless they are based on intent or gross negligence or the explicit written assurance of features. Please see our website for full warranty Terms and Conditions.

10. Reservation of ownership

We reserve ownership to all delivered goods subject to reservation until complete payment has been received. The recipient is entitled to resell the goods in the ordinary course of business. Additional disposition (pledge as collateral, transfer by way of security or sale after effected cessation of payments) is not permitted. Garnishments or goods subject to reservation must be reported immediately with provision of the garnishment protocol. If the customer sells or disposes of goods subject to reservation for credit, then the resulting purchase price demand with accrual is considered to be surrendered to us. The customer is authorized to collect these demands until he is banned from doing so due to payment delay or financial collapse. In this case, the customer must submit to us a statement of transfer and a confirmation of reservation of title by third parties. We reserve the right to changes in size and color as well as technical improvements. All plans, sketches, drawings, illustrations or other documentation remains our property. These items may not be made accessible to third persons without our explicit written permission, nor may they be copied or duplicated.

11. Rescission

We can withdraw from a contract if the customer provided us with incorrect data about his credit worthiness and if we become aware of circumstances which justify doubts about the customer's credit worthiness or the credit worthiness becomes invalid: i.e. dishonored checks or notes, request for affidavit, non-insurability with a credit insurance, etc.) or if a petition for insolvency proceedings is filed.

12. Place of performance and jurisdiction

The place of jurisdiction for all legal disputes arising from the existing legal relationship with the customer - including notes and checks - is the Bulgaria, Kazanlak and Stara Zagora.

13. Written form and invalidity, severability clause

Changes to this contract to be valid always require them to be in written form. Even if one of more sections of this clause or a significant part of these clauses become invalid fully or in part, the effectiveness of the remaining clauses still remains intact.

Contacts



RUSSIA (Head Office):
LLC NPO Promet

Industrial area Promet, Sosenki, 108803 MOSCOW
Tel: +7 (495) 617-12-49
E-mail: export@promet-safe.com
www.promet-safe.com



BULGARIA:
Promet Bulgaria OOD

zh.k. Sveta Troitza, bl. 347B parter, 1309 SOFIA
Tel: + 359 (2) 934-98-20
E-mail: bg.im@promet-safe.bg
www.promet-bg.com



ESTONIA:
Eurosafe

Tammsaare Aric Center. Tammsaare tee 47, 11316, TALLINN
Tel: +372 556 55354
E-mail: seif@eurosafe.ee
www.euro-seifid.ee



GERMANY:
Mitteldeutsche Tresorbau GmbH

Zschochersche Strasse 82, D-04229 LEIPZIG
Tel: +49 341 49558080
E-mail: info@mdtb.de
www.promet-safe.com/de



KAZAKHSTAN:
TOO Promet Safe

Office 1: av. Abaya 11, Office 2: ul.Zhanazhol 3/3, 010000 ASTANA
Tel: +7 (701) 999-55-19
E-mail: de@promet-safe.com
www.promet-safe.kz



LATVIA:
Eurosafe

Unimarine Business Center. Dunties 17th LV-1005, RIGA
Tel: +371 674 81999
E-mail: safe@eurosafe.lv
www.eurosafe.lv



LITHUANIA:
Eurosafe

Business Center Trapeze. Pilaites pr. 16, LT-04352, VILNIUS
Tel: +370 675 05551
E-mail: seifas@eurosafe.lt
www.euro-seifai.lt



POLAND:
Promet Safe Sp. z.o.o.

ul. Łowicka 22 lok U1, 02-502 WARSAW
Tel: +48 22 393 11 50
E-mail: info@promet-safe.pl
www.promet-safe.pl



UKRAINE:
TOV Praktik Pro

Novokonstantinovskaya Str. 9, 4080, KYIV
Tel: +380 44 206-69-61
E-mail: dumansky@praktik-pro.com.ua
www.praktik-pro.com.ua



PROMET

Feel Safe ■

60, Rozova dolina str.,
Kazanlak, Bulgaria, 6100
Phone / Fax: +359 (4) 316-28-43
www.promet-safe.com